

KRUUSE Infusion Concept



Content

	Introduction	03
	SafeVet IV Catheters	04
	IV Catheters	08
	SafeVet Infusion Sets	10
	Infusion Sets	11
	Extension Lines	14
	Butterflies	19
	Accessories	20
	Infusion Therapy Guidelines	22

KRUUSE Infusion Concept

Infusion therapy is a vital treatment in veterinary medicine.
Individualised treatments are tailored to meet the patient's exact condition.

Therefore, understanding infusion therapy is a big part of being a vet or vet nurse. You must know the need for fluid therapy, methods of providing fluids, types of fluids available, and how to keep patients safe during treatment.

But, to carry out best practice, you need the proper aids. You need products that ease treatment for the animal while offering you a safe and efficient working environment.

KRUUSE infusion products are designed to provide easy venous access while minimising pain and discomfort for the patient.

Don't settle for basic!

Try our new KRUUSE SafeVet products.

SafeVet products are safety editions of the most popular KRUUSE infusion products, allowing you to carry out infusion procedures **with a reduced risk for needlestick injuries, contamination, disconnection, and phlebitis.**

In short, KRUUSE SafeVet products ensure safe working conditions for vets and vet nurses, while treating and caring for patients.

Dive in to the KRUUSE INFUSION CONCEPT - and don't miss out on the very informative Infusion Therapy Guidelines.

ENJOY!



KRUUSE SafeVet Combi Set

The needle-free injection site gives you a safe and quick access to administer medication directly IV while infusion therapy is on-going.

Reduced risk for

- Phlebitis
- Needlestick injuries
- Contamination
- Disconnection

Closed system ensures

- Concurrent infusion and injection
- Adequate pressure
- No blood reflux

Optimal tubing

- Softens at body temperature
- Long indwelling time
- Visible in X-ray

Improved working procedures

The closed IV catheter system supports two infusions at the same time - infusion and injection. It secures an adequate pressure, that prevents reflux of blood and blood clots in the catheter tubing in between procedures or when immediate infusions are needed.

Safety for the vet

The safety needle guard automatically covers the needle's sharp bevel after withdrawal from the hub and minimises the risk of needlestick injuries.

Less risk for the animal

The KRUUSE SafeVet Combi Set minimises the number of manipulations, thus reducing the risk of contamination and accidental disconnection of the IV catheter.

The risk of mechanical phlebitis is markedly reduced as the work and handling of the device is separated from the catheter tubing vein inlet - making this the gold standard in human medicine.



High quality materials for extra animal comfort

KRUUSE SafeVet Combi Sets are constructed with highly biocompatible polyurethane tubing that allows for longer indwelling time and include built-in features that prioritise patient comfort.

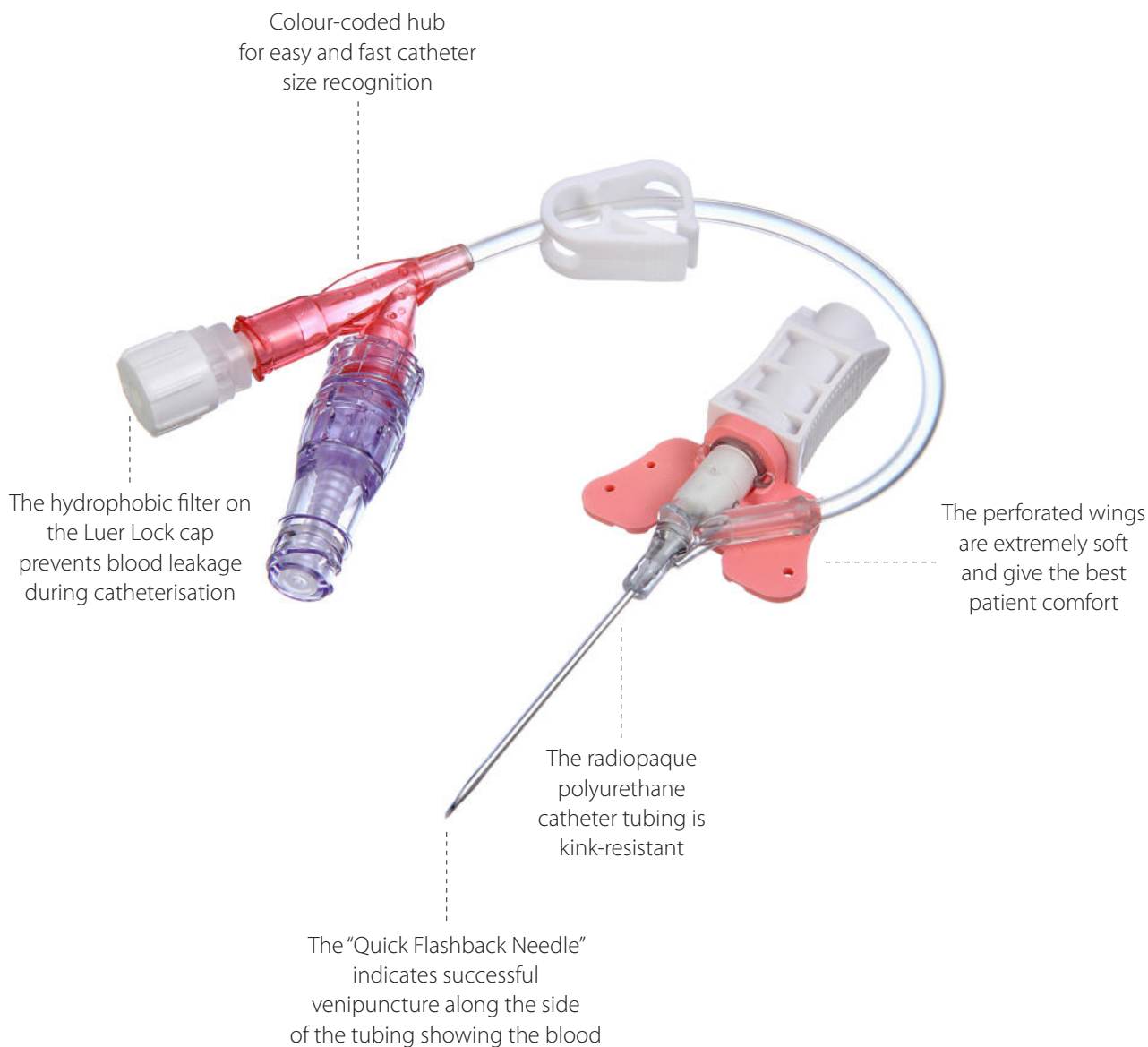

Cat. No	Description	Priming volume	Size, Metric	Size, Imperial	Colour	Package
230180	KRUUSE SafeVet IV Combi Set	0.208 ml	0.7 x 19 mm	24G x 3/4"	Yellow	20/pk
230181	KRUUSE SafeVet IV Combi Set	0.255 ml	0.9 x 25 mm	22G x 1"	Blue	20/pk
230182	KRUUSE SafeVet IV Combi Set	0.353 ml	1.1 x 32 mm	20G x 1 1/4"	Pink	20/pk

KRUUSE SafeVet InfuVein

The popular KRUUSE InfuVein Catheter with injection port is now available in a safety edition with automatic safety mechanism.

User-friendly and safe

Once placed correctly intravenously it is easy and fast to use the injection port for medication and the snap cap ensures easy closure.

The safety needle guard automatically covers the needle's sharp bevel after withdrawal from the hub and minimises the risk of needlestick injuries.

Choose the correct IV catheter size

Reduce the risk of phlebitis by using the smallest catheter possible, which at the same time gives adequately IV fluid volume.

High quality for extra animal comfort

Features like biocompatible polyurethane tubing that softens at body temperature ensure a higher level of animal comfort.

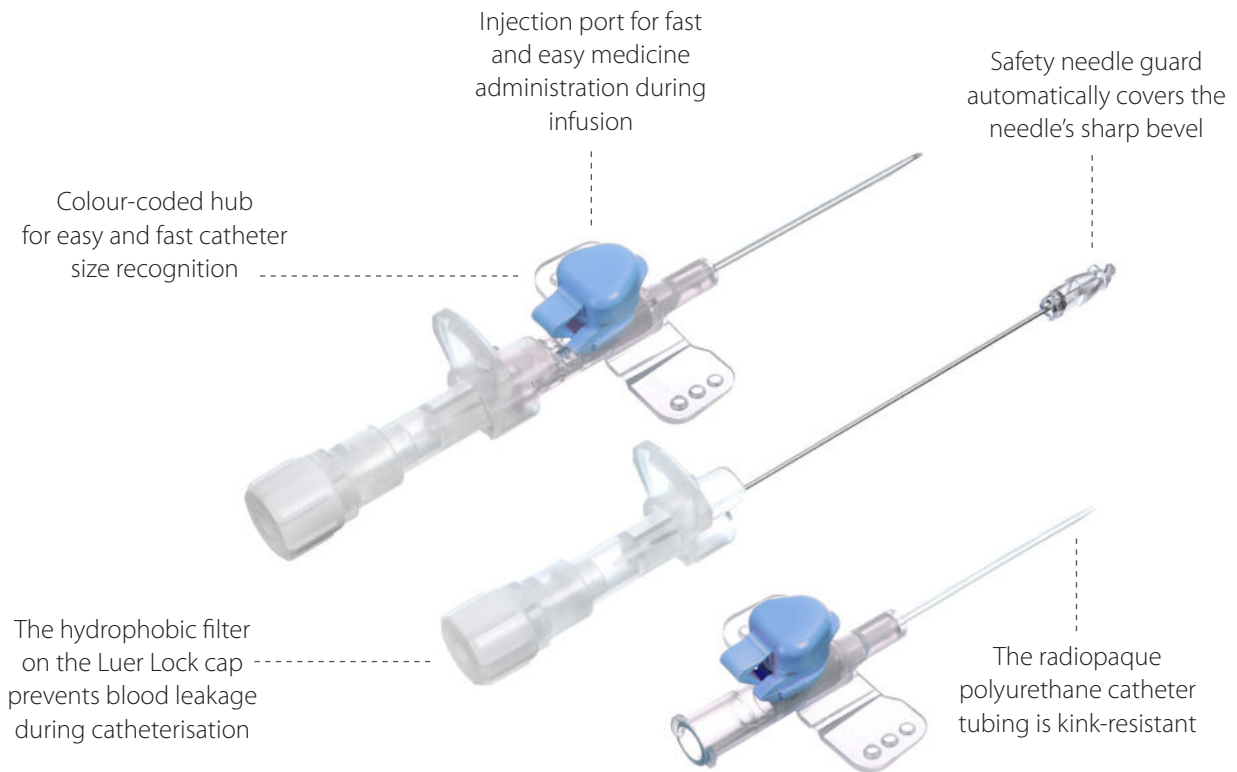

Cat. No	Description	Size, Metric	Size, Imperial	Colour	Package
230187	KRUUSE SafeVet InfuVein	0.7 x 19 mm	24G x ¾"	Yellow	50/pk
230188	KRUUSE SafeVet InfuVein	0.9 x 25 mm	22G x 1"	Blue	50/pk
230189	KRUUSE SafeVet InfuVein	1.1 x 32 mm	20G x 1¼"	Pink	50/pk



KRUUSE SafeVet Pencil Style

The popular Pencil Style Catheter is now available in a safety edition with automatic safety mechanism.

User-friendly and safe

Completely insert the catheter post-venipuncture with just a push of your index finger on the handle on the hub.

The safety needle guard automatically covers the needle's sharp bevel after withdrawal from the hub and minimises the risk of needlestick injuries.

Choose the correct IV catheter size

Reduce the risk of phlebitis by using the smallest catheter possible, which at the same time gives adequately IV fluid volume.

High quality for extra animal comfort

Features like biocompatible polyurethane tubing that softens at body temperature ensure a higher level of animal comfort.

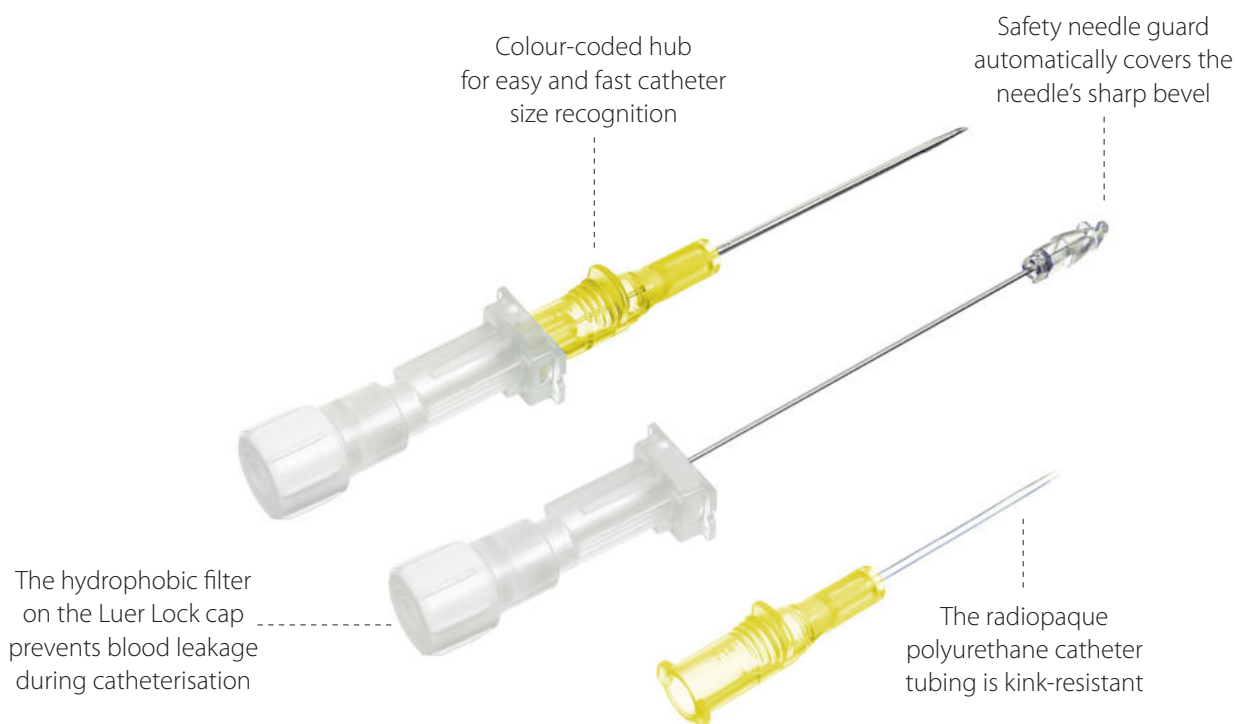

Cat. No	Description	Size, Metric	Size, Imperial	Colour	Package
230184	KRUUSE SafeVet Pencil Style	0.7 x 19 mm	24G x 3/4"	Yellow	50/pk
230185	KRUUSE SafeVet Pencil Style	0.9 x 25 mm	22G x 1"	Blue	50/pk
230186	KRUUSE SafeVet Pencil Style	1.1 x 32 mm	20G x 1 1/4"	Pink	50/pk



KRUUSE IV Catheters

KRUUSE IV Catheters are thoughtfully designed with sharp needles and long bevels to minimise pain and discomfort during placement. Blood is visible via transparent flash-back chambers to ensure correct placement. Each IV catheter is individually packed in a blister pack for easy access.

KRUUSE InfuVein PRO IV Catheter

- Kink-resistant polyurethane tubing softens at body temperature and gives more comfort to the animal
- Coloured cap on the injection port makes administration of medication easy
- A 10 ml syringe (or smaller) ensures that the resistance in the catheter is not too strong
- The primary port can also be used for fluid therapy



Cat. No	Description	Size, Metric	Size, Imperial	Colour	Package
121914	KRUUSE InfuVein PRO	0.7 x 19 mm	24G x 3/4"	Yellow	50/pk
121915	KRUUSE InfuVein PRO	0.9 x 25 mm	22G x 1"	Blue	50/pk
121916	KRUUSE InfuVein PRO	1.1 x 32 mm	20G x 1 1/4"	Pink	50/pk
121913	KRUUSE InfuVein PRO	1.3 x 32 mm	18G x 1 1/4"	Green	50/pk
121917	KRUUSE InfuVein PRO	1.3 x 45 mm	18G x 1 3/4"	Green	50/pk



KRUUSE Venocan PLUS IV Catheter

- FEP tubing material
- Flexible wings provide a good grip during catheterisation
- Thin-walled catheter with a large inner diameter assures good flow



Cat. No	Description	Size, Metric	Size, Imperial	Colour	Package
121906	KRUUSE Venocan PLUS	0.7 x 19 mm	24G x 3/4"	Yellow	50/pk
121907	KRUUSE Venocan PLUS	0.9 x 25 mm	22G x 1"	Blue	50/pk
121908	KRUUSE Venocan PLUS	1.1 x 32 mm	20G x 1 1/4"	Pink	50/pk
121912	KRUUSE Venocan PLUS	1.3 x 32 mm	18G x 1 1/4"	Green	50/pk
121909	KRUUSE Venocan PLUS	1.3 x 45 mm	18G x 1 3/4"	Green	50/pk
121910	KRUUSE Venocan PLUS	1.7 x 50 mm	16G x 2"	Grey	50/pk
121911	KRUUSE Venocan PLUS	2.1 x 50 mm	14G x 2"	Orange	50/pk

KRUUSE IV Catheters

KRUUSE Venocan Mini IV Catheter

- FEP tubing material
- Small and flexible wings for increased patient comfort
- Thin-walled catheter with a large inner diameter assures good flow
- Available in the popular size 26G for small species, including reptiles and birds



Cat. No	Description	Size, Metric	Size, Imperial	Colour	Package
121940	KRUUSE Venocan Mini	0.6 x 13 mm	26G x 1/2"	Yellow	50/pk
121941	KRUUSE Venocan Mini	0.7 x 19 mm	24G x 3/4"	Yellow	50/pk
121942	KRUUSE Venocan Mini	0.9 x 25 mm	22G x 1"	Blue	50/pk
121943	KRUUSE Venocan Mini	1.1 x 32 mm	20G x 1 1/4"	Pink	50/pk

KRUUSE Venocan Pencil Style IV Catheter

- FEP tubing material
- Popular and simple Pencil Style IV Catheter without wings and injection port
- Thin-walled catheter with a large inner diameter assures good flow



Cat. No	Description	Size, Metric	Size, Imperial	Colour	Package
121933	KRUUSE Venocan Pencil Style	0.7 x 19 mm	24G x 3/4"	Yellow	50/pk
121932	KRUUSE Venocan Pencil Style	0.9 x 25 mm	22G x 1"	Blue	50/pk
121931	KRUUSE Venocan Pencil Style	1.1 x 32 mm	20G x 1 1/4"	Pink	50/pk
121930	KRUUSE Venocan Pencil Style	1.3 x 45 mm	18G x 1 3/4"	Green	50/pk

KRUUSE SafeVet Infusion Set

KRUUSE IV infusion set with air vent and needle-free injection site.

Provides

- Easy administration
- Flow rate regulation

Reduced risk for

- Stick injuries

User-friendly and safe

The needle-free injection site is placed 30 cm from the distal end of the tubing, reducing the risk of stick injuries and easing the administration of periodic medication.

A sharp and winged spike ensures easy insertion into the IV fluid container, and the flow rate can easily be regulated by adjusting the roller clamp.

The transparent and flexible drip chamber is easy to fill and the air vent, which must be closed during periods of interrupted infusion therapy, prevents under-pressure.

Easy attachment

The rotating Luer Lock fitting at the distal end eases attachment to the IV catheter.

Be careful not to over-hydrate the patient and do not leave patients unattended during fluid therapy.

- Drip chamber with 15-micron fluid filter
- Soft and kink-resistant PVC tubing, 200 cm
- Tube diameter: Ø 4.1 mm (O.D.)
- DEHP free, latex free

Cat. No 230635
30/pk



Disposable IV Infusion Sets for Gravity Use

The air vent prevents under-pressure in the fluid container and chamber during infusion.

The Y-injection site is suitable for administration of medicine through the membrane while infusion is on-going.

- Y-injection site
- Air vent
- Rolling clamp
- Rotating Luer Lock



Cat. No	Description	Drops/ml	Size, Metric	Size, Imperial	Package
230632	KRUUSE Infusion Set, standard	20 drops/ml	200 cm	74"	30/pk
230633	KRUUSE Infusion Set, microset	60 drops/ml	200 cm	74"	30/pk

KRUUSE Small Animal Spiral Infusion Set

The long and curly spiral tubing prevents the animal from slipping or stumbling, allowing the hospitalised patient to move freely while in a cage.

Free movement and adaptation

The tubing will be kept close to the infusion bottle and upon movement it will be prolonged simply by a gentle pull.

The rotating Luer Lock fitting eases attachment to the IV catheter and ensures free movement of the infusion set when the animal moves around. Furthermore, it reduces the risk of phlebitis, as the mechanical impact of the IV catheter is reduced.

Improved working procedures

The Y-injection site allows giving medication periodically, while infusion is on-going, saving time and easing treatment for the animal.

The flow rate can easily be regulated to the desired flow by adjusting the roller clamp.

Be careful not to over-hydrate the patient and do not leave patients unattended during fluid therapy.

Cat. No 230647
25/pk

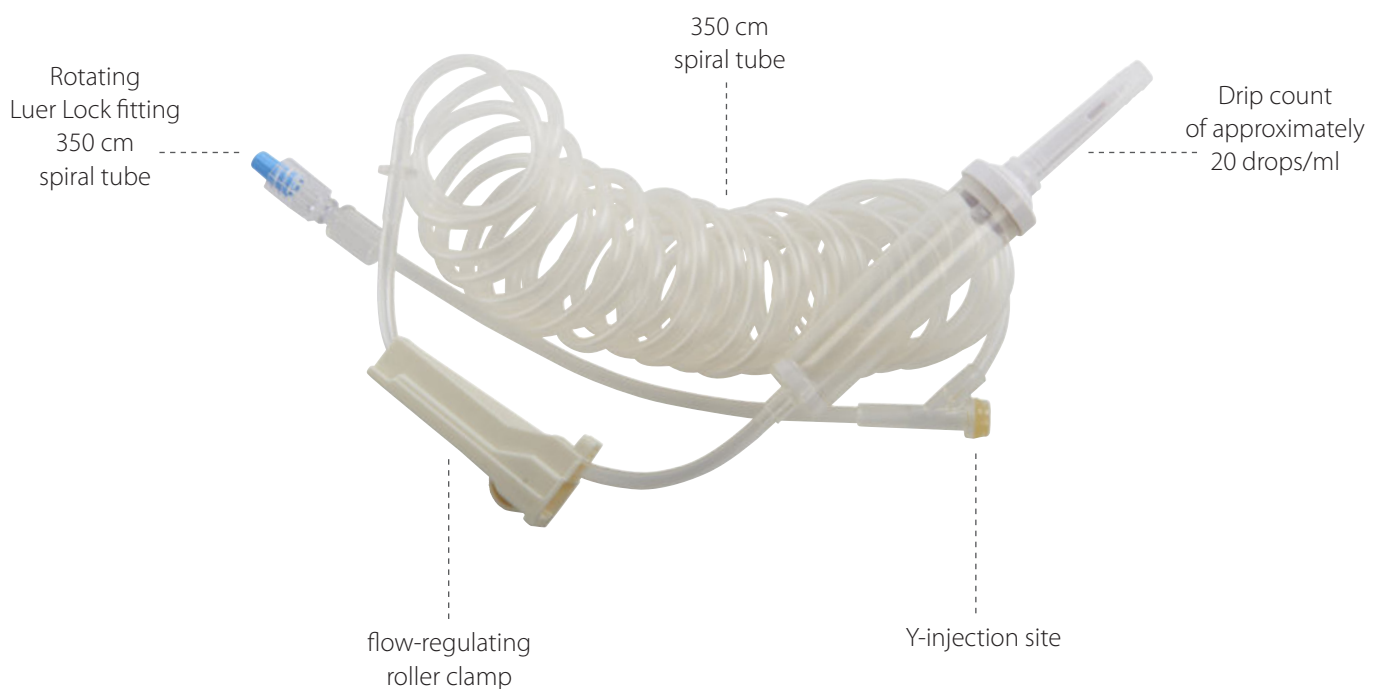

KRUUSE Burette Set

The preferred IV infusion set for accurate and controlled infusion for small animals like small cats, kittens, puppies and ferrets.

Provides

- High dosing accuracy
- Volume control

Suitable for

- Very small animals
- Controlled infusion therapy

Controlled and accurate

The KRUUSE Burette Set offers volume control, which ensures high accuracy in dosing for very small animals receiving fixed volumes of 0-150 ml.

The automatic closing valve safeguard that the fluid inflow automatically stops at the pre-set volume without allowing air in the tubing.

Easy and time saving

The Y-injection site allows giving medication periodically, while infusion is on-going, saving time and eases treatment for the animal.

By using the KRUUSE Burette Set an infusion pump is not required.

Length: 150 cm

Cat. No 230646

1/pk

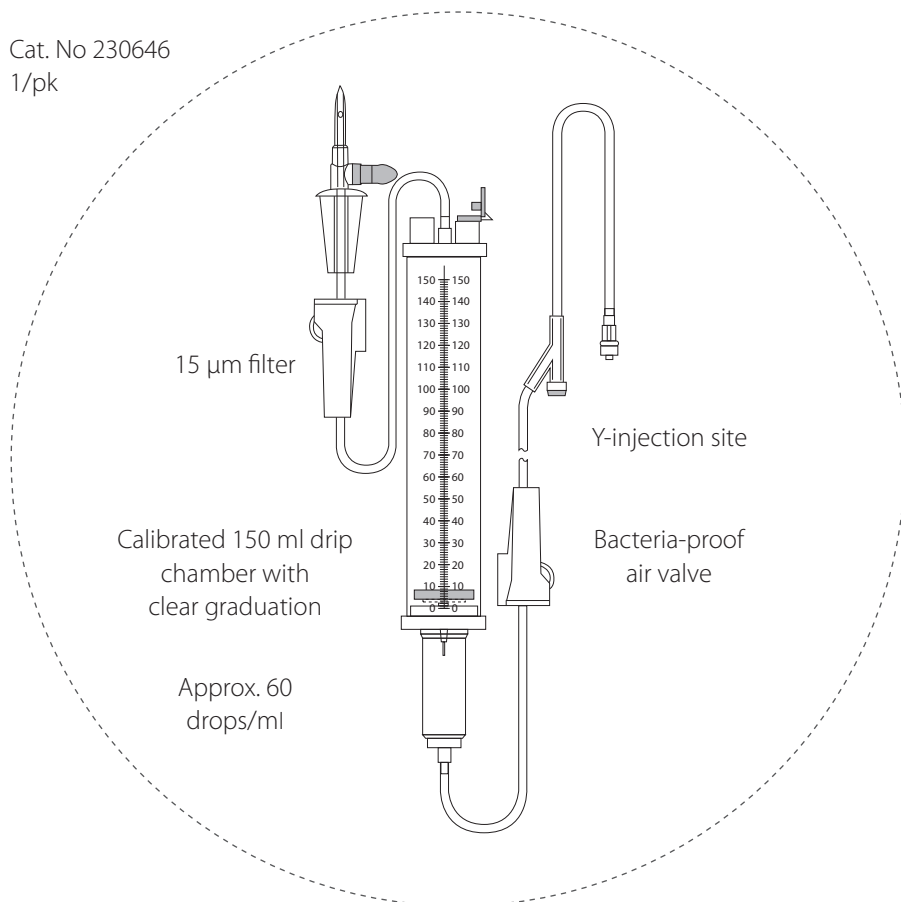

KRUUSE Y-extension Tube with Three-way Tap

Easy fluid administration

The extension tube has a 3-way stop cock at one end, enabling you to turn infusion on and off. The rotating male Luer Lock at the other end eases attachment and ensures free movement.

The matted PVC tube is flexible and kink-resistant to ensure smooth flow.

Easy handling

The Y-injection site allows giving medication periodically, while infusion is on-going, saving time and easing treatment for the animal.

The easy-to-turn tap handle rotates 360° and has an arrow that indicates the flow direction. It comes with two female Luer Lock connectors.

Length: 10 cm

Cat. No 230651

1/pk



IV Flow Regulator Extension Set

For controlled and accurate infusion - DEHP and latex free

Controlled fluid therapy

The adjustable flow regulator on the KRUUSE IV extension tube has dosing from 5 to 250 ml per hour, allowing you to have fairly accurate and controlled infusion, without the need for an infusion pump.

The soft and kink-resistant PVC tubing ensures a uniform flow rate.

Compatible and easy to use

Inclusion of male and female Luer Locks makes it compatible with other IV devices.

The Y-injection site allows giving medication periodically, while infusion is on-going, saving time and easing treatment for the animal.

Standard bore diameter: 4.1 mm

Total length: 40 cm

Accuracy: +/- 10%

Cat. No 230640

45/pk



KRUUSE T-connector

The KRUUSE T-connector connects two IV administration devices at the desired angles, allowing for easier IV administration. In addition, the injection port provides another access point for periodic injections.

- Allows **periodic injections** via membrane during simultaneous infusion
- **Reduces phlebitis-risk:** Reduces the risk of cannula movement in the vein causing mechanical vein irritation, when used with an IV catheter
- Rotating male Luer Lock ensures **easy handling** during attachment
- Micro-bore tubing for **minimal priming volume**

Length: 15 cm

Cat. No 230142

50/pk

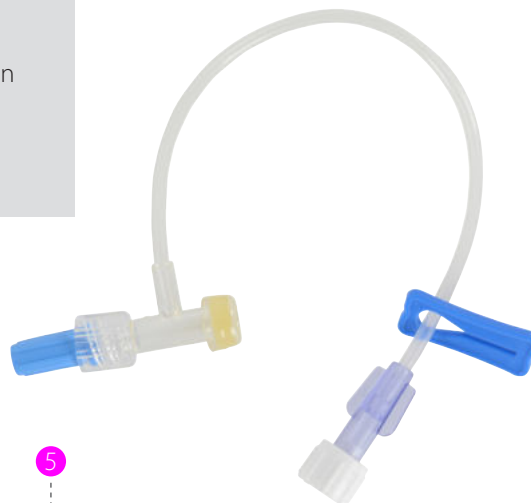

1. Female Luer Lock with protective cap
2. Handle
3. Slide clamp
4. Micro-bore tubing, 15 cm
5. Injection site
6. Male Luer Lock with rotating collar



KRUUSE SafeVet Microbore Extension Line

Tailor your fluid equipment set-up to small patients and volumes.

Fluid therapy is important for many medical conditions in veterinary patients. Fluid therapy is dictated by the patient's needs, including volume, rate and fluid composition. Needs may vary according to the existence of either acute or chronic conditions and patient pathology.

Fluid therapy must be individualised, tailored to each patient, and constantly re-evaluated and reformulated according to changes in patient status.

- Suitable for small patients and small volumes
- Extra access point allows treatment during infusion
- Minimising risks of phlebitis by reducing direct contact with the IV access point
- Easy attachment by transparent rotating Luer Lock

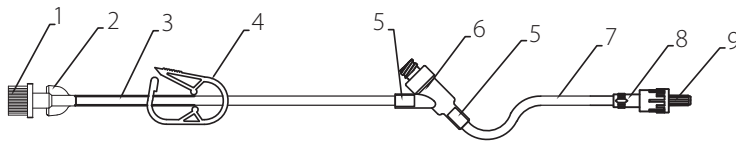
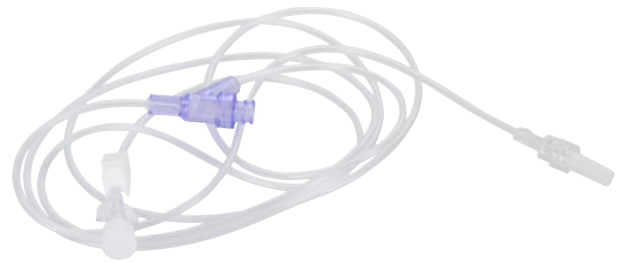

1. Protective cap
2. Female Luer Lock
3. Tubing - 420 mm OD 2.5 mm ID 1.3 mm
4. Robert clamp
5. Tubing - 10 mm OD 3.9 mm ID 2.4 mm
6. Needle free injection site
7. Tubing - 300 mm OD 2.5 mm ID 1.3 mm
8. Rotary male Luer Lock for microbore
9. Protective cap



Cat. No	Description	Size, Metric	Size, Imperial	Priming Volume	Package
230167	KRUUSE SafeVet Microbore Extension Line	75 cm	30"	1.2 ml	50/pk
230166	KRUUSE SafeVet Microbore Extension Line	175 cm	70"	2.6 ml	50/pk

KRUUSE Microbore Extension Line with Y-injection Site

Tailor your fluid equipment set-up to small patients and volumes.

Fluid therapy is important for many medical conditions in veterinary patients. Fluid therapy is dictated by the patient's needs, including volume, rate and fluid composition. Needs may vary according to the existence of either acute or chronic conditions and patient pathology.

Fluid therapy must be individualised, tailored to each patient, and constantly re-evaluated and reformulated according to changes in patient status.

- Suitable for small patients and small volumes
- Extra access point allows treatment during infusion
- Minimising risks of phlebitis by reducing direct contact with the IV access point
- Easy attachment by transparent rotating Luer Lock

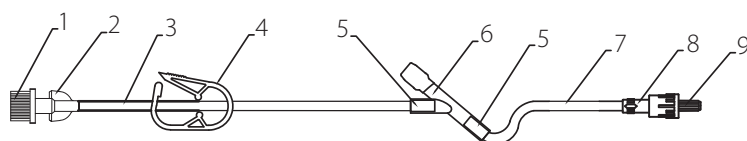

1. Protective cap
2. Female Luer Lock
3. Tubing - 1440 mm OD 2.5 mm ID 1.3 mm
4. Robert clamp
5. Tubing - 10 mm OD 3.9 mm ID 2.4 mm
6. Y-Injection site
7. Tubing - 300 mm OD 2.5 mm ID 1.3 mm
8. Rotary male Luer Lock for microbore
9. Protective cap



Cat. No	Description	Size, Metric	Size, Imperial	Priming Volume	Package
230169	KRUUSE Microbore Extension Line with Y-injection Site	75 cm	30"	1.2 ml	50/pk
230168	KRUUSE Microbore Extension Line with Y-injection Site	175 cm	70"	2.6 ml	50/pk

KRUUSE Extension Line

Fluid therapy is important for many medical conditions in veterinary medicine. KRUUSE Extension Lines ease in-clinic procedures.

Fluid therapy must be individualised, tailored to each patient, and constantly re-evaluated and reformulated according to changes in status. Follow the guideline of the hospital or clinic.

Instructions for use

1. Connect the extension line to the IV catheter at one end and the infusion set at the other end and extend the scope of the line
2. Connect the female Luer Lock of the extension tube to the male fitting of the infusion set
3. Remove the protective cap of the male Luer Lock, expel the air from the tube and close the regulating clamp
4. Connect the male Luer Lock to the IV device and regulate the flow by adjusting the rolling clamp to achieve the desired flow rate

Never leave patients receiving IV fluid unattended.



Cat. No	Description	Size, Metric	Size, Imperial	Bore Ø	Package
230150	KRUUSE Extension Line	25 cm	10"	4.2 mm	50/pk
230151	KRUUSE Extension Line	75 cm	30"	4.2 mm	50/pk
230152	KRUUSE Extension Line	100 cm	39"	4.2 mm	50/pk
230153	KRUUSE Extension Line	150 cm	59"	4.2 mm	50/pk

KRUUSE Butterfly

Designed to provide quick, short-term venous with minimised pain and discomfort.

Sterile IV Butterflies are ideal for blood sampling, injection or short-term infusion

- Butterfly-shaped wings for easy handling
- Thin wall needles provide better flow rate per gauge
- Long bevel minimises discomfort and pain during placement
- Tube with Luer Lock fitting for secure attachment of syringe
- Colour-coded wings for instant identification of needle size
- Soft, non-toxic, non-irritant, medical grade tube

Cat. No	Description	Size	Size, Imperial	Colour	Package
121716	KRUUSE Butterfly	0.6 x 19 mm	23 G x 3/4"	●	50/pk
121717	KRUUSE Butterfly	0.8 x 19 mm	21 G x 3/4"	●	50/pk
121718	KRUUSE Butterfly	1.1 x 19 mm	19 G x 3/4"	●	50/pk

Tube length 30 cm

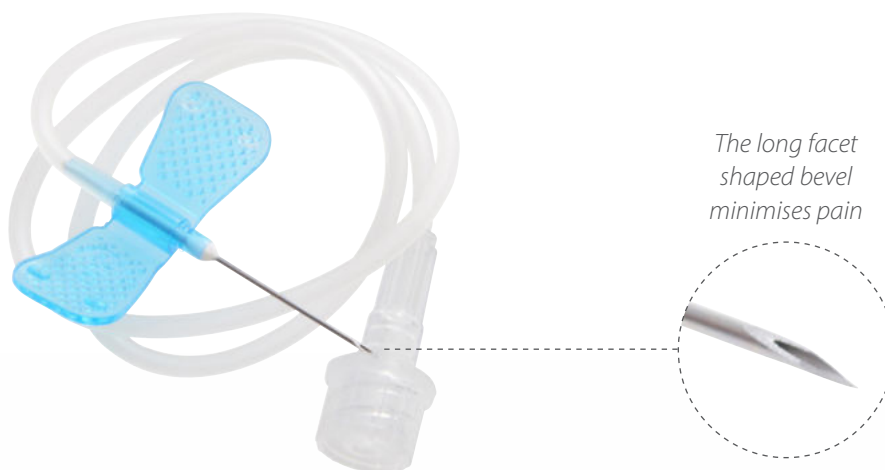

The long facet shaped bevel minimises pain



KRUUSE SafeVet Spike

By using the KRUUSE SafeVet Spike with your vials, you can withdraw medication without using a needle, thus reducing the risk of needlestick injuries.

Perfect for

- Multiple fluid withdrawals
- Fast and easy withdrawals also with more viscous fluids

Reduced risk for

- Needlestick injuries
- Contamination

Free from

- DEHP
- PVC
- Latex

The KRUUSE SafeVet Spike is intended to simplify withdrawals of fluids from vials and semi-rigid containers.

The hydrophobic air-bacteria filter allows air into the vial without risking contamination, which eases withdrawal of medication and fluids.

The KRUUSE SafeVet Spike comes with a snap-cap for easy closing of the cap.

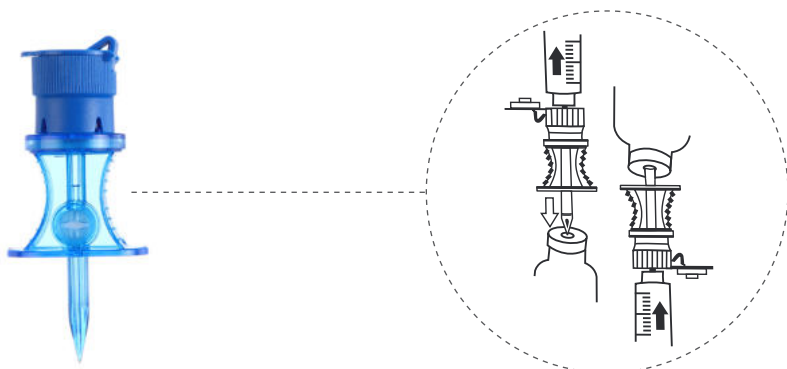

Discard the KRUUSE SafeVet Spike after single vial use.

Cat. No 230162
15/pk



KRUUSE SafeVet Injection Site

Reduce stick injuries with easier, safer access.

The KRUUSE SafeVet Injection Site is fixed to the IV catheter instead of the usual cap or stylet. Once in place, the clinical staff can make injections through the needle-free valve without removing it from the IV catheter.

Needle-free injection reduces the amount of stick injuries.



Cat. No 230161
50/pk



KRUUSE Three-way Tap

IV accessory for multiple infusions for easy and gentle patient care.

The device has a minimum priming volume, which is required for accurate drug administration. The channel is transparent for improved visibility of the fluids.

The rotating male Luer Lock eases attachment and ensures free movement.

The easy-to-turn tap handle rotates 360° and has an arrow that indicates the flow direction. It comes with two female Luer Lock connectors.

Cat. No 230648
50/pk



KRUUSE Luer Lock Cap

Place and secure the KRUUSE Luer Lock Cap on the IV catheter or any other product that needs to be closed with a Luer Lock cap. KRUUSE Luer Lock Caps are individually packed in blisters to secure sterility.

Cat. No 230677
200/pk



KRUUSE Heparin Cap

Fast and easy medicine administration.

The KRUUSE Heparin Cap is intended for use attached to an IV catheter instead of the usual cap or stylet.

Once in place, the clinical staff can make injections through the membrane without removing the cap, thus making the administration of medicine more effective.

Individually packed in blisters.

Cat. No 230675
100/pk



KRUUSE IV Anchor

A simple solution to a common problem in small animal practice.

The KRUUSE IV Anchor prevents the infusion line from kinking and ensures a continuous fluid flow. Simply place the IV anchor at any point on the infusion line where it may kink to stabilise the line, secure the catheter and avoid occlusions. Designed for standard-sized infusion lines (O.D. ~4 mm) in a bright green colour for easy visibility.

Cat. No 230607
10/pk

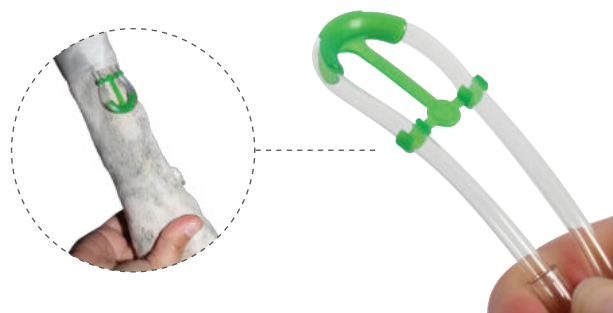

Infusion Therapy Guidelines



Infusion Therapy Guidelines

Understanding infusion therapy is an important skill for vets and veterinary technicians. Key points include knowing when there is a need for fluid therapy, methods of providing fluids, types of fluids available, and how to keep patients safe while providing this vital treatment.

KRUUSE's mission is to help improve animal well-being and health by preventing and reducing suffering. We strive to share best practices by working closely with leading specialists.

In these guidelines we will focus on intravenous fluid therapy.

A big thank you to Liz Hughston, MEd, RVT, CVT, VTS (SAIM, ECC) for sharing her knowledge with us on infusion therapy. Read more about Liz Hughston at the end of these guidelines.

Individualized Care

- Fluid therapy must be individualized and tailored to each patient
- Therapy is constantly re-evaluated and reformulated according to changes in patient status
- Fluid selection is dictated by the patient's needs, including volume, rate and fluid
- Composition required, and location the fluid is needed (interstitial versus intravascular)
- The appropriate route of fluid administration depends on the patient's condition
 - Use oral fluids for patients with a functioning gastrointestinal system and no significant fluid imbalance
 - Use subcutaneous fluids to prevent losses. This route is not adequate for replacement therapy in anything other than very mild dehydration
 - Use intravenous or intra-osseous fluids for patients undergoing anesthesia; for hospitalized patients not eating or drinking normally; and to treat dehydration, shock, hyperthermia or hypotension

Source: https://www.aaha.org/globalassets/02-guidelines/fluid-therapy/fluidtherapy_guidelines_toolkit.pdf



Body Water Compartments

To understand fluid therapy and its applications, one must first understand the distribution of fluid and water in the body. Total body water (TBW) comprises approximately 60% of a patient's body weight. Approximately 67% of TBW is found inside the body's cells and is referred to as intracellular fluid (ICF).

The remaining 33% of TBW is the extracellular fluid (ECF), which is further divided as follows:

- Interstitial fluid, which bathes cells and tissues (~24% of TBW)
- Plasma, the liquid portion of blood, which constitutes most of intravascular volume (~8%–10% of TBW)
- Transcellular fluid, which comprises synovial joint fluid, cerebrospinal fluid, bile, and the fluid in the linings of the peritoneal cavity, pericardium, and pleural space (~2% of TBW)

Source: <https://todaysveterinarynurse.com/articles/the-basics-of-fluid-therapy-for-small-animal-veterinary-technicians/>



Reasons for Fluid Therapy

A variety of patient conditions can lead to a need for fluid therapy.

Veterinary professionals provide fluid therapy to patients for many reasons, including correction of dehydration, expansion and support of intravascular volume, correction of electrolyte disturbances, and encouragement of appropriate redistribution of fluids that may be in the wrong compartment (e.g., peritoneal effusion).¹

The examination should include full blood work including chemistry, complete blood count and measuring of electrolytes.

The first step in determining whether a patient needs fluid therapy is a full physical examination, including collection of a complete anamnesis. The veterinary staff must assess whether the patient is perfusing its tissues well, check for dehydration, and evaluate losses from any of the fluid compartments.²

Source: <https://todaysveterinarynurse.com/articles/the-basics-of-fluid-therapy-for-small-animal-veterinary-technicians/>

Developing and Implementing a Fluid Therapy Plan

There is a helpful guideline when it comes to fluid therapy: Replace like with like. This means if a patient has lost blood, that fluid should be replaced with plasma, pRBCs, or whole blood. If a patient has lost body fluids through diarrhea, vomiting, or excessive urination, replacement should be with similarly constituted isotonic crystalloid fluids. While development of the

fluid plan is ultimately the veterinarian's purview, it is important for veterinary nurses and technicians to understand the fluids available and for what conditions they might be used in clinical practice.

Source: <https://todaysveterinarynurse.com/articles/the-basics-of-fluid-therapy-for-small-animal-veterinary-technicians/>

Calculation of Fluid Volume

BOX 4 Fluid Therapy Formulas

*UC Davis School of Veterinary Medicine fluid therapy formula.

Calculation of Dehydration Deficit¹

Body weight (kg) x dehydration as a decimal = liters of fluid required to correct dehydration

Calculation of Maintenance Fluid Requirements*

Dogs: Body weight (kg)^{0.75} x 132 = 24-hour fluid requirement in milliliters

Cats: Body weight (kg)^{0.75} x 80 = 24-hour fluid requirement in milliliters

Ongoing losses (e.g., from diarrhea, vomiting, or polyuria) must be calculated and added to the total maintenance requirement obtained from these formulas.

Source: <https://www.vin.com/apputil/content/defaultadv1.aspx?pld=11196&id=3854241>



Recommended maintenance fluid rates (mL/kg/hr) – Rule of thumb:

Cats: 2-3 mL/kg/hr

Dogs: 4-6 mL/kg/hr

Source: <https://www.aaha.org/aaha-guidelines/fluid-therapy/quick-reference-fluid-tables/maintenance-fluid-rates/>

Fluid Selection

Fluids can be classified as **crystalloids** and **colloids**.

Crystalloid is a common term for the small molecular salt solutions mentioned below and colloid is the common term for the solutions with bigger molecules, which stay in circulation for a longer time.

Crystalloids

Parenteral fluid packages provide a list of the solute content and osmolality. This information is important when deciding which fluid to use in each particular clinical situation. Fluids can be conveniently classified on the basis of tonicity (Table 2).

Isotonic fluids contain the same osmolality as the extracellular fluids (approximately 290 to 310 mOsm/L). Commonly used isotonic solutions include lactated Ringer's, 0.9 percent (normal or physiologic) saline; Ringer's, acetated Ringer's, and 2.5% dextrose in 0.45% saline.

Lactated Ringer's solution (LRS) is a polyionic, **isotonic** (273 mOsm/L) solution. It is more physiologic than isotonic saline because its electrolyte concentration is similar to that of plasma. Although each liter contains 4 mEq of potassium, supplementation with this cation is usually required for the patient's maintenance needs. Considerably more is required for treating hypokalemia. Because the bicarbonate derived from the lactate can promote alkalemia, this solution should not be used if the patient has a coexisting metabolic or respiratory alkalosis. LRS is commonly used as a routine rehydrating and maintenance solution, as a plasma space volume expander in the treatment of shock, and as the fluid of choice in the acidotic patient.

An **acetated Ringer's** solution is also available. Its uses and restrictions are similar to those for LRS. Theoretically, sodium acetate is preferable to sodium lactate because a significant part of the latter anion is converted into liver glycogen, whereas acetate ions are not metabolized by the liver but by muscles and other peripheral tissues. Acetated solutions should not be used for treating ketoacidosis, because the acetate might promote acetoacetate production.

Ringer's solution is an **isotonic** saline solution (309 mOsm/L), with potassium and calcium ion concentrations approximately equal to those normally found in blood and extracellular water. The chloride concentration, however, is supraphysiologic (155 mEq/L). Potassium and calcium ions should be added when patients are depleted of these cations.

"Physiologic," 0.9% saline (NS) is also **isotonic** (310 mOsm/L) and is commonly used for rehydration. However, because of its supraphysiologic levels of sodium and chloride ions (154 mEq/L), it is not recommended for maintenance. This solution is mainly used for plasma volume expansion, for the correction of hyponatremia, and, along with potassium chloride supplementation for the treatment of metabolic alkalosis. Once plasma volume deficits are restored to normal, NS should not be used in animals with congestive heart failure or other conditions in which sodium restrictions are imposed.

Dextrose 2.5% in 0.45% saline is nearly isotonic (280 mOsm/L). Once rehydration has been accomplished and normal electrolyte balance has been restored, it is a useful maintenance solution when supplemented with potassium chloride. It is also the fluid of choice for patients whose sodium intake is restricted and those that tend to develop hypernatremia with NS (as seen in some azotemic cats with urethral obstruction).

The osmolality of **hypotonic solutions** is less than that of plasma and extracellular water. The most commonly used product is **5% dextrose** solution (D-5-W; 253 mOsm/L).

It is mainly used (1) in patients with hypernatremia, because the dilutional effects will lower the serum sodium level; (2) as a carbohydrate source when another polyionic electrolyte solution is used concomitantly, and (3) as a fluid supplement for patients with sodium intolerance. D-5-W should not be the sole intravenous fluid for maintenance therapy because electrolyte depletion states hyponatremia, hypochloremia, hypokalemia, and hypomagnesemia can result.

Hypertonic solutions have a higher osmolality than plasma and extracellular fluid. The most commonly used hypertonic solution is **dextrose 5% in 0.9% saline** (560 mOsm/L).

It can be used as a partial maintenance solution once the patient is completely rehydrated. It is best administered slowly IV. This solution should never be used in a dehydrated animal because it will promote cellular dehydration and intensify the

hypovolemia by stimulating diuresis before adequate plasma volume expansion has been achieved. This fluid can be used as an energy source and as a sodium supplement in the well hydrated, hyponatremic patient.

Small-volume hypertonic saline solution (7.5%) has recently been suggested as a means of effective initial resuscitation from hemorrhagic shock.^{4,5} Infusion of 4 to 5 ml/kg of sodium chloride 7.5% (2400 mOsm/L) in hemorrhagic shock can rapidly increase systemic blood pressure and cardiac output and produce elevated renal, total splanchnic, and coronary blood flow.

Colloids

Whole blood, plasma, and colloidal plasma expanders are valuable for increasing the circulating blood volume when shock is present. Most of the solution is retained within the vascular system, where it increases the osmotic pressure of the blood above that of the extravascular fluid spaces. Consequently, water passes from the interstitial fluid space into the blood, increasing the circulating blood volume.

Plasma is the most commonly used colloid solution in veterinary medicine. Its main advantage stems from the colloid osmotic pressure provided by plasma proteins. It is useful for treating hypoproteinemic conditions such as chronic liver disease, protein-losing enteropathy, and glomerulopathy. The main disadvantages of plasma are that its availability is limited, its effects are temporary, and it is expensive.

Dextrans are synthetic colloids derived from sugar beets. Dextran 70 and 40 are available in 5% dextrose or saline solutions. Dextran 40 has the advantage of retarding formation of rouleaux and sludging of red blood cells, thus improving micro-circulation above and beyond simple volume expansion.⁶ Disadvantages include coagulopathies as a result of decreased platelet function and altered fibrin clot formation. Other problems include renal failure, anaphylaxis, and depressed immune function.⁴

Hydroxyethyl starch (Hetastarch) is a synthetic polymer derived from a waxy starch composed mostly of amylopectin. Like albumin, it expands the circulating plasma volume. Its osmolality is approximately 310 mOsm/L. The expanded plasma volume may last for 24 hours or longer. Hydroxyethyl starch is available as a 6% solution in saline. It should be infused slowly at a rate of 10 to 20 ml/kg/day.

Source: <https://www.vin.com/apputil/content/defaultadv1.aspx?pld=11196&id=3854241>



Comparison of Parenteral Fluids in the Dog and Cat

Solution	Electrolyte Content (mEq/L)					Lactate	Acetate	Glucose (g/L)	Calories Kcal/L	Tonicity	Osmolality (mOsm/L)
	Na ⁺	N ⁺	Ca ⁺⁺	Cl ⁻	Mg ⁺⁺						
Lactated Ringer's	130	4	3	109		28				Isotonic	273
Acetated Ringer's	131	4	3	98	3		28			Isotonic	295
Ringer's	147	4	4	155						Isotonic	310
Sodium chloride 0.45%	77		77							Hypotonic	155
Sodium chloride 0.9%	154		154							Isotonic	310
Dextrose 2.5%								25	85	Hypotonic	126
Dextrose 5%								50	170	Hypotonic	253
Dextrose 10%								100	340	Hypotonic	505
Dextrose 50%								500	1700	Hypotonic	2525
Dextrose 2.5% in halfstrenght lactated Ringer's	65	2	1	55		14		25	85	Isotonic	265
Dextrose 5% in lactated Ringer's	130	4	3	111		28		50	170	Hypotonic	525
Dextrose 2.5% with 0.45% sodium chloride	77		77					25	55	Isotonic	280
Dextrose 5% with 0.45% sodium chloride	77		77					50	170	Hypotonic	405
Dextrose 5% with 0.9% sodium chloride	154		154					50	170	Hypotonic	560

Source: <https://www.vin.com/apputil/content/defaultadv1.aspx?pld=11196&id=3854241>



IV Catheter

The most common IV catheter placement in small animals is in the cephalic vein located on the dorsal foreleg.

Vena saphena lateralis on the hind leg or *vena jugularis* are also options, but less common for ordinary IV catheter placement.

Catheter size should be based on the type and size of patient and treatment. If you are dealing with a shock patient, choose the largest catheter possible.

The larger the catheter diameter, the faster fluid inflow. Another general guideline is that shorter catheters provide the faster inflow. When not dealing with shock patients or severely dehydrated patients, choose a catheter size with space between the catheter and the vein wall, which will reduce the risk of phlebitis.

Monitoring Fluid Volume

The fluid volume can be monitored either by an infusion pump, a drip counter, a burette infusion set or by adjusting the flow rate on a regular gravity infusion set.

Regardless of the method, it is important to never leave patients receiving fluid therapy unattended, as over-hydration can be life-threatening.

Fluid overload is a major complication of fluid therapy and can lead to pulmonary edema, ascites, and peripheral edema with the potential for development of compartment syndrome.

A patient who becomes tachypneic, develops clear nasal discharge, or is found to have crackles on thoracic auscultation while receiving fluid therapy should be suspected of becoming overhydrated. If these signs are noted, particularly in combination with an increase in body weight, IV fluid therapy should be stopped and the veterinarian should be notified immediately.³

Chemosis (swelling of the conjunctiva) is a late sign of fluid overload and requires urgent treatment, including cessation of IV fluids and potential administration of diuretic agents.

Go with the flow!

A thorough understanding of fluid therapy, including the methods of providing fluids, the types of fluids available, and how to keep patients safe while providing treatment is vital.

Be critical, look things up or ask a colleague to ensure that you choose the right fluid, volume, and flow rate.



Again thank you to Liz Hughston MEd, RVT, CVT, VTS (SAIM, ECC)

- Liz practices as a relief veterinary technician and consultant in the San Francisco Bay Area for both general and emergency/specialty practices
- She graduated from Foothill College in 2006 and went on to earn her certification as a veterinary technician specialist in both small animal internal medicine and emergency and critical care in 2012
- Liz is dedicated to advancing veterinary nursing through training and mentorship and is a frequent and sought-after national and international speaker
- In 2013, Liz was awarded the California Registered Veterinary Technician's Association's inaugural RVT of the Year Award, recognizing her efforts to improve veterinary nursing in California and beyond

References

1. Creedon JM, Davis H. Catheterization of the venous compartment. In: *Advanced Monitoring and Procedures for Small Animal Emergency and Critical Care*. Chichester, West Sussex, UK: Wiley-Blackwell; 2012:51-68.
2. Davis H, Jensen T, Johnson A, et al. 2013 AAHA/AAFP fluid therapy guidelines for dogs and cats. *JAAHA* 2013;49(3):149-159.
3. Mazzaferro EM. Fluid therapy: the critical balance between life and death. *Clinician's Brief* 2006:73-75.

JØRGEN KRUUSE A/S
Havretoften 4
DK-5550 Langeskov - Denmark
Tel.: +45 72 14 14 14
Fax: +45 72 14 15 00
www.kruuse.com